

GERBER NOTES

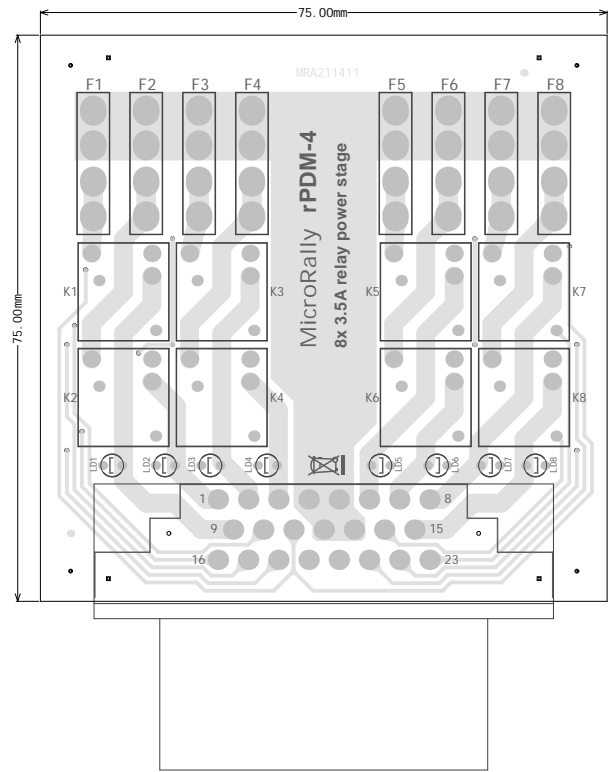

Symbol	Count	Hole Size	Plated	Hole Type	Via/Pad
⊕	13	0.300mm	PTH	Round	Via
◇	16	0.750mm	PTH	Round	Pad
☆	16	0.800mm	PTH	Round	Pad
■	4	1.152mm	NPTH	Round	Pad
▽	24	1.300mm	PTH	Round	Pad
□	23	1.600mm	PTH	Round	Pad
⊗	32	2.500mm	PTH	Round	Pad
○	2	2.850mm	NPTH	Round	Pad
⊙	4	3.200mm	NPTH	Round	Pad
	134 Total				

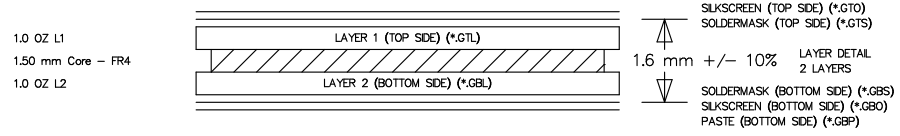

1.0 OZ L1
 1.50 mm Core - FR4
 1.0 OZ L2

NOTES: (UNLESS OTHERWISE SPECIFIED)

- THIS IS 2 LAYER BOARD
- MATERIAL: FR4, TG 150 DEGREE C MIN
- FR4 DIELECTRIC CONSTANT NOT SPECIFIED
- FINISHED BOARD THICKNESS TO BE 1.60MM +/- 10%
- TRACE WIDTHS IN ARTWORK ARE FINISHED SIZES
- SEE FILM FOR LAYER SEQUENCE AND COPPER THICKNESSES (SHOWN BEFORE PLATING)
- MIN TRACE/SPACE 0.60/0.25MM
- SEE DRILL CHART FOR FINISHED HOLE SIZES
- MIN DRILL 0.75MM
- HOLE TOLERANCE IS +/-3MIL UNLESS OTHERWISE SPECIFIED
 HOLE COPPER THICKNESS MIN 0.7MIL
 SLOT TOLERANCE +/-0.1MM
 BORDER OUTLINE TOLERANCE +/-0.15MM
- SURFACE PLATING: HASL, Pb FREE
- SOLDERMASK: LPI, BOTH SIDES. COLOR GREEN
- SILKSCREEN: TOP AND BOTTOM SIDE. COLOR WHITE
- ALL BOARDS MUST BE ELECTRICALLY TESTED FOR ISOLATION (SHORTS) AND CONTINUITY (OPENS)

Project: rPDM-4	
Author: Andis Jargans	Revision: 1
Date: 11.04.2021	Size: A4
File: rPDM-4_r1.PcbDoc	MicroRally

GERBER NOTES

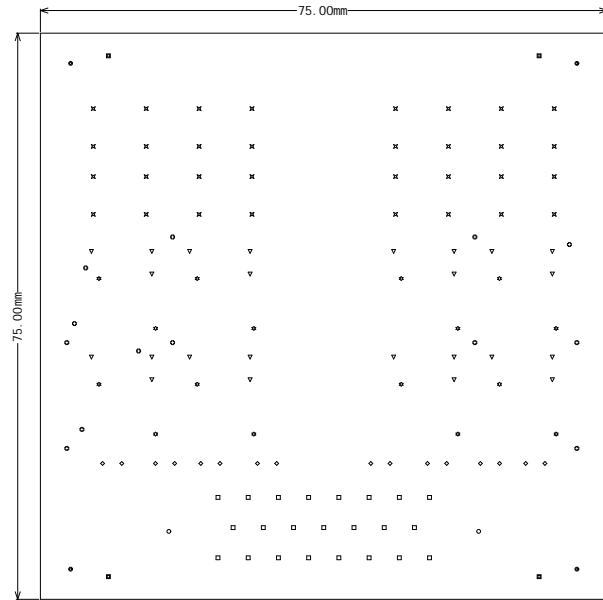

Symbol	Count	Hole Size	Plated	Hole Type	Via/Pad
⊕	13	0.300mm	PTH	Round	Via
◇	16	0.750mm	PTH	Round	Pad
☆	16	0.800mm	PTH	Round	Pad
■	4	1.152mm	NPTH	Round	Pad
▽	24	1.300mm	PTH	Round	Pad
□	23	1.600mm	PTH	Round	Pad
⊗	32	2.500mm	PTH	Round	Pad
○	2	2.850mm	NPTH	Round	Pad
⊙	4	3.200mm	NPTH	Round	Pad
	134 Total				

1.0 OZ L1
 1.50 mm Core - FR4
 1.0 OZ L2

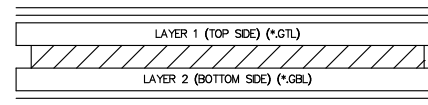

SILKSCREEN (TOP SIDE) (*GTO)
 SOLDERMASK (TOP SIDE) (*GTS)
 1.6 mm +/- 10% LAYER DETAIL
 2 LAYERS
 SOLDERMASK (BOTTOM SIDE) (*GBS)
 SILKSCREEN (BOTTOM SIDE) (*GB0)
 PASTE (BOTTOM SIDE) (*GBP)

NOTES: (UNLESS OTHERWISE SPECIFIED)

- THIS IS 2 LAYER BOARD
- MATERIAL: FR4, TG 150 DEGREE C MIN
- FR4 DIELECTRIC CONSTANT NOT SPECIFIED
- FINISHED BOARD THICKNESS TO BE 1.60MM +/- 10%
- TRACE WIDTHS IN ARTWORK ARE FINISHED SIZES
- SEE FILM FOR LAYER SEQUENCE AND COPPER THICKNESSES (SHOWN BEFORE PLATING)
- MIN TRACE/SPACE 0.60/0.25MM
- SEE DRILL CHART FOR FINISHED HOLE SIZES
- MIN DRILL 0.75MM
- HOLE TOLERANCE IS +/-3MIL UNLESS OTHERWISE SPECIFIED
 HOLE COPPER THICKNESS MIN 0.7MIL
 SLOT TOLERANCE +/-0.1MM
 BORDER OUTLINE TOLERANCE +/-0.15MM
- SURFACE PLATING: HASL, Pb FREE
- SOLDERMASK: LPI, BOTH SIDES. COLOR GREEN
- SILKSCREEN: TOP AND BOTTOM SIDE. COLOR WHITE
- ALL BOARDS MUST BE ELECTRICALLY TESTED FOR ISOLATION (SHORTS) AND CONTINUITY (OPENS)

Project: rPDM-4	
Author: Andis Jargans	Revision: 1
Date: 11.04.2021	Size: A4
File: rPDM-4_r1.PcbDoc	Microwally

ASSEMBLY NOTES

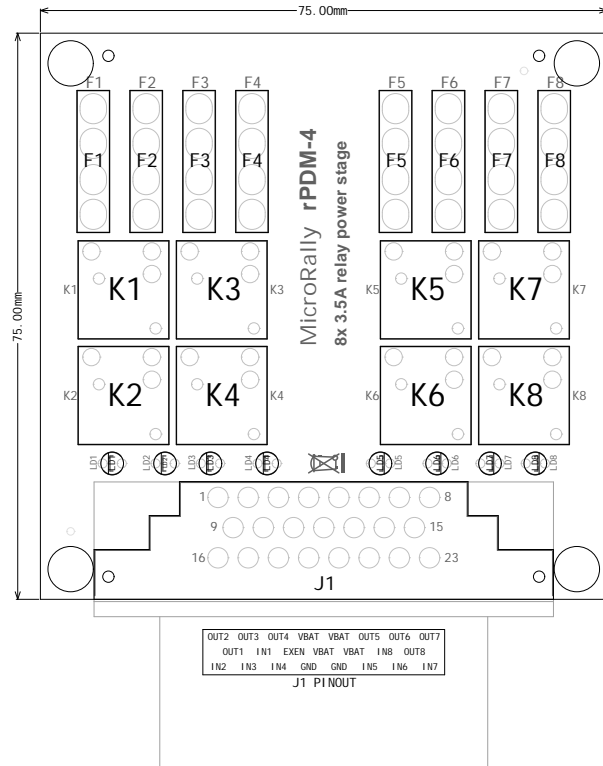

Project: rPDM-4	
Author: Andi s Jargans	Revi si on: 1
Date: 11.04.2021	Si ze: A4
Fi le: rPDM-4_r1.PcbDoc	Mi croRal ly

MRA211411

F1 F2 F3 F4

F5 F6 F7 F8

MicroRally rPDM-4
8x 3.5A relay power stage

K1

K3

K5

K7

K2

K4

K6

K8



1

8

9

15

16

23

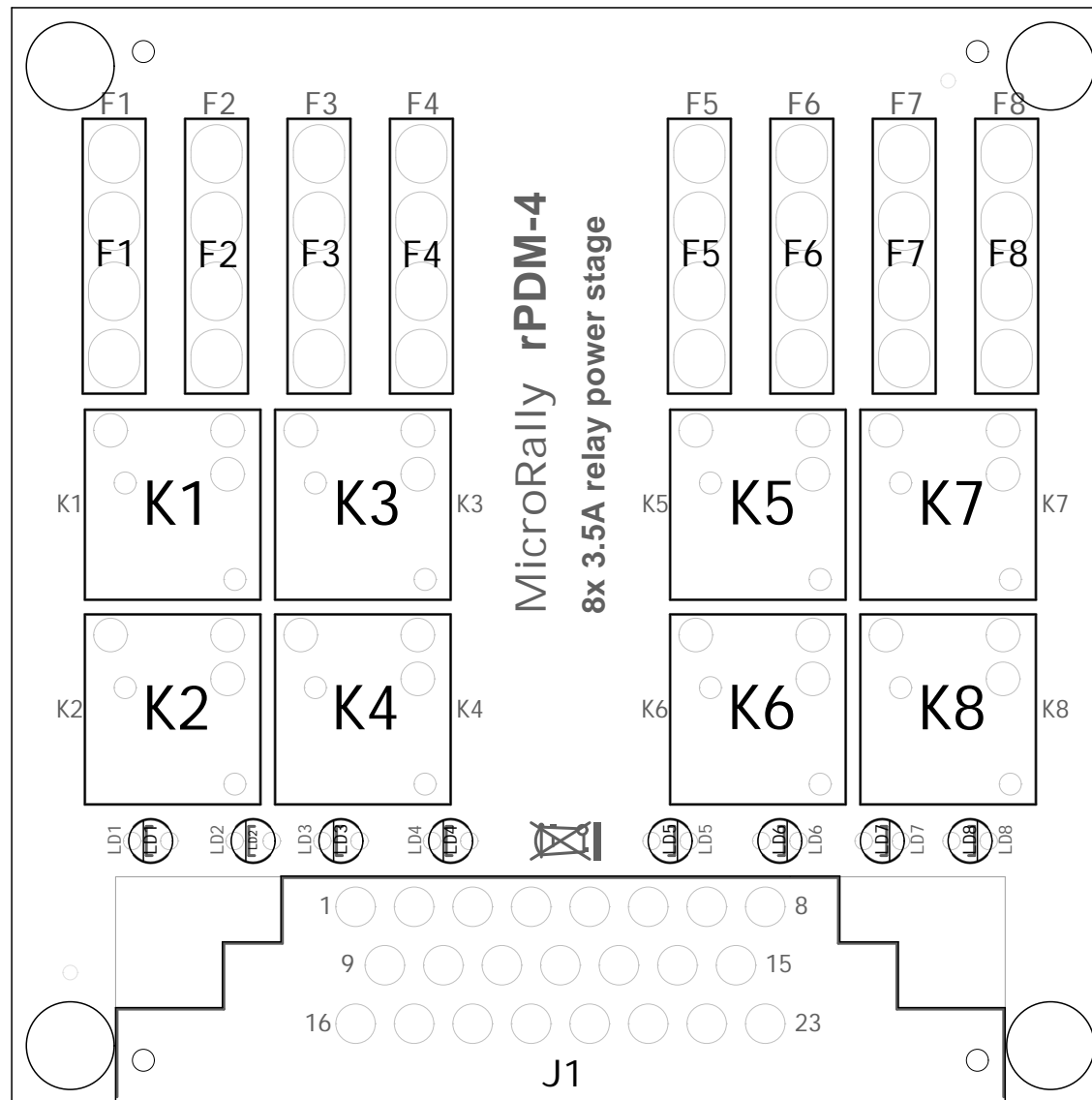

OUT2	OUT3	OUT4	VBAT	VBAT	OUT5	OUT6	OUT7
OUT1	IN1	EXEN	VBAT	VBAT	IN8	OUT8	
IN2	IN3	IN4	GND	GND	IN5	IN6	IN7

J1 PINOUT

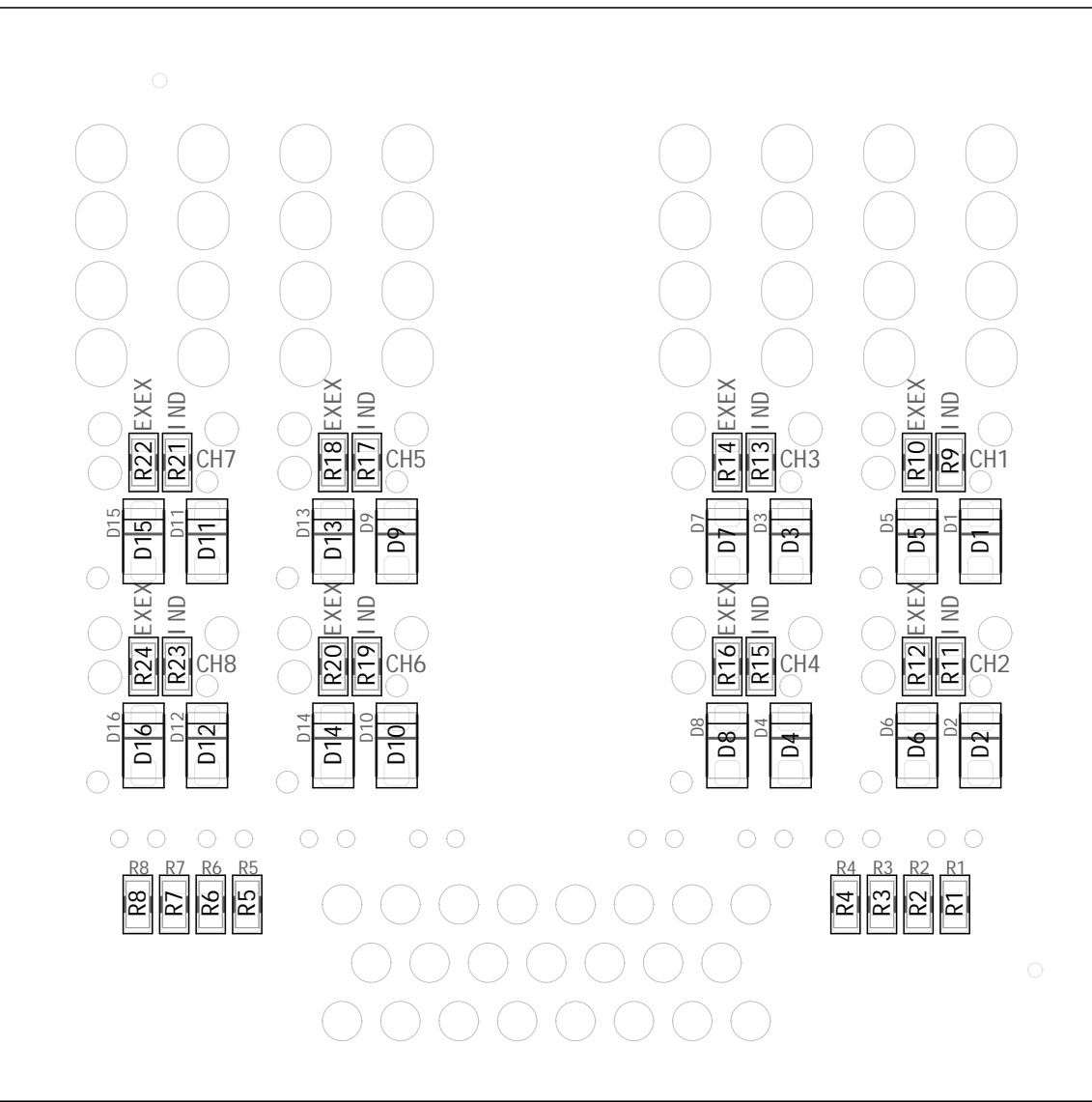

MRA211411

