

# MicroRally

## rPDM-5

Revision 1

4x 7.5A channel relay power stage, with active high control

Title: Cover sheet	MicroRally
Project: rPDM-5	Revision: 1
Size: A4	Page 1 of 3
Author: Andis Jargans	Date: 14.04.2021
File name: Title.SchDoc	

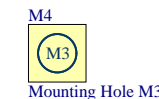
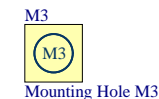
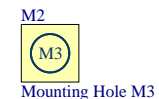
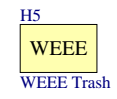
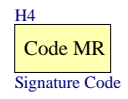
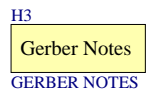
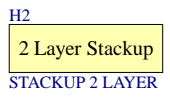
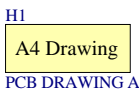
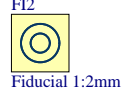
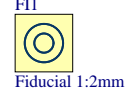
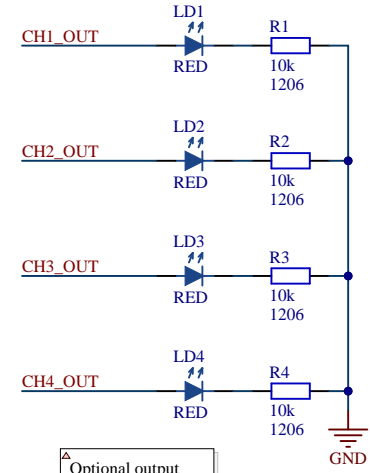
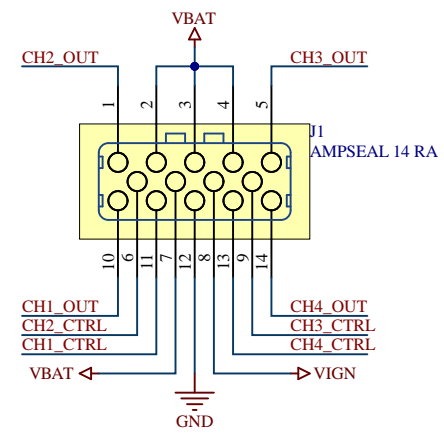
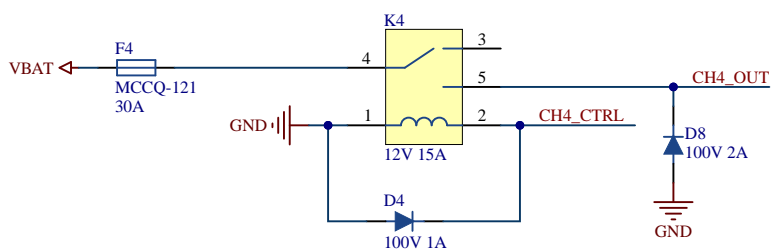
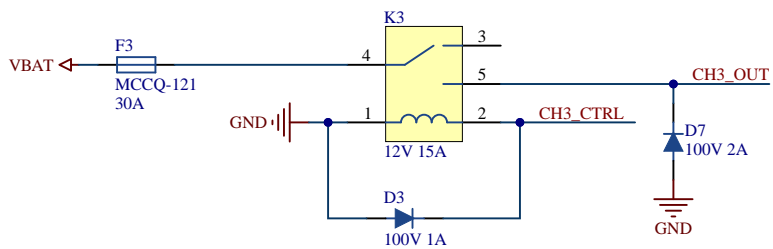
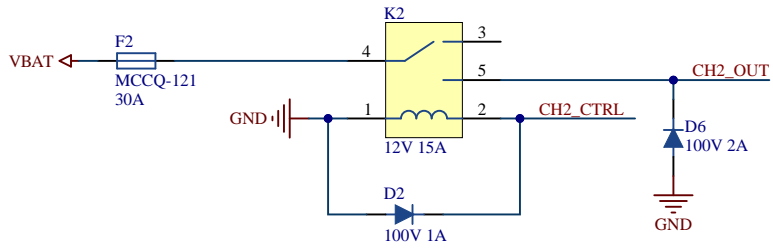
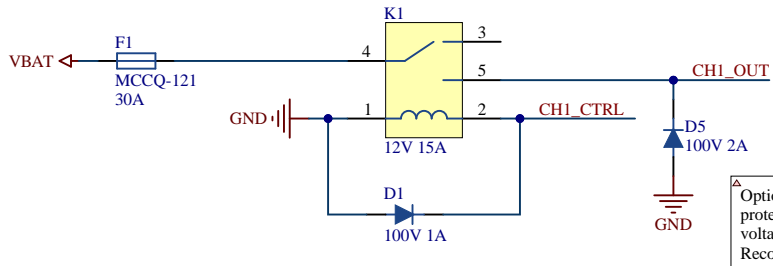

Title: Connections	MicroRally
Project: rPDM-5	Revision: 1
Size: A4	Page 2 of 3
Author: Andis Jargans	Date: 14.04.2021
File name: Connections.SchDoc	

**Revision history**

Revision	Date	Fixed issue	Changes
r1	2021-04-14		Initial design.

A

A

B

B

C

C

D

D

Title: Revision History	MicroRally
Project: rPDM-5	Revision: 1
Size: A4	Page 3 of 3
Author: Andis Jargans	Date: 14.04.2021
File name: History.SchDoc	